



FUJITEC

GS ESCALATOR
8000-NX



EN115

ESCALATOR

Fujitec's GS8000-NX places special importance on the passenger's safety adopting not only a variety of safety devices but also providing higher balustrade (plus 50mm compared to our conventional model).

User-friendliness

Illuminated Direction Indicator with high level of visibility

Superb riding comfort

Exceptional smoothness & quietness

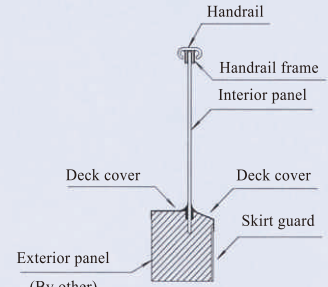
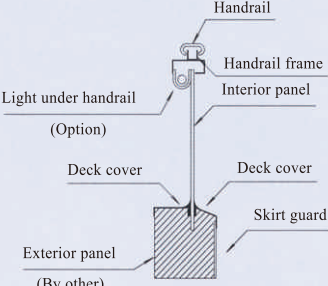
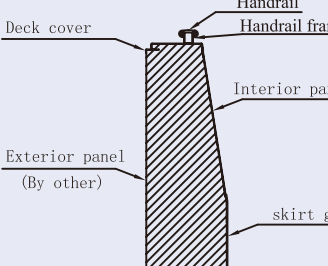

Variety of Types

<p>Type-S</p>	<p>[Slim type] Interior panels are made of clear tempered glass which provides a sophisticated appearance.</p> <p>Indoor use. ($H \leq 9.5m$) Outdoor use. ($H \leq 6.0m$)</p>	
<p>Type-F</p>	<p>[Frame type] (Lighting is option) Interior panels are made of clear tempered glass Optional lighting under the handrails creates an elegant look</p> <p>Indoor & Outdoor use.</p>	
<p>Type-P</p>	<p>[Panel type] Interior panels are made of hairline-finished stainless steel and are ideally suited for public transit systems.</p> <p>Indoor & Outdoor use.</p>	

Notes:
Type-S & F are suited for commercial facilities.
Type-P is suited for public transit systems as well as commercial facilities.

Specifications

●: Standard Spec. ■: Optional Spec.

Balustrade			
Handrail	Synthetic Rubber (black)	●	
	Polyurethane (black & 7 colors)	■	
Deck Cover (Only S&F type)	Hairline-finished Stainless Steel	●	
Interior Panel	Type-S,F: Colorless, Clear Tempered Glass	●	
	Type-P: Hairline-finished Stainless Steel	●	
Skirt Guard	Type S/F	Indoor: steel with black coating	●
		Outdoor: Hairline finished stainless steel	●
		Hairline finished stainless steel (Indoor)	■
	Type P	Steel with low friction coating (Indoor)	■
		Stainless steel with low friction coating	■
		Hairline finished stainless steel	●
Stainless steel with low friction coating	■		
Step			
Tread	Indoor: Stainless Steel (black) with Synthetic Resin Demarcation (yellow)	●	
	Outdoor: Aluminum Alloy Die-cast (gray) with painted Demarcation (yellow)	●	
	Aluminum Alloy Die-cast (gray)	■	
Demarcation Line for Aluminum Step	Painted (yellow)	●	
	Synthetic Resin (yellow)	■	
Floor Plate			
Comb	Synthetic Resin (yellow)	●	
Landing Plate	Aluminum	●	
	Hairline-finished Stainless Steel	■	

Basic Specifications

Item	Model S600	Model S800	Model S1000
Step width (mm)	600	800	1000
Max. vertical rise (m)	For 30° Type-S: 9.5; Type-F, P: 14.0		
	For 35° Type-S, F, P: 6.0		
Inclination (degrees)	30°/35°		
Speed (m/min)	30/27		
Transportation capacity (Passengers / hour)	4500	6750	9000
Power	380V/400V/415V 50HZ		
	220V/380V 60HZ		

Notes:
1) The above specifications are based on EN115.
2) The above specifications shall be changed according to the applied code.

All Computer Graphics may differ from actual appearance.
Specifications and features are subject to change without notice.

Safety Devices

Fujitec's GS8000-NX series escalators come with various safety devices designed with the priority concept of passenger's safety first.

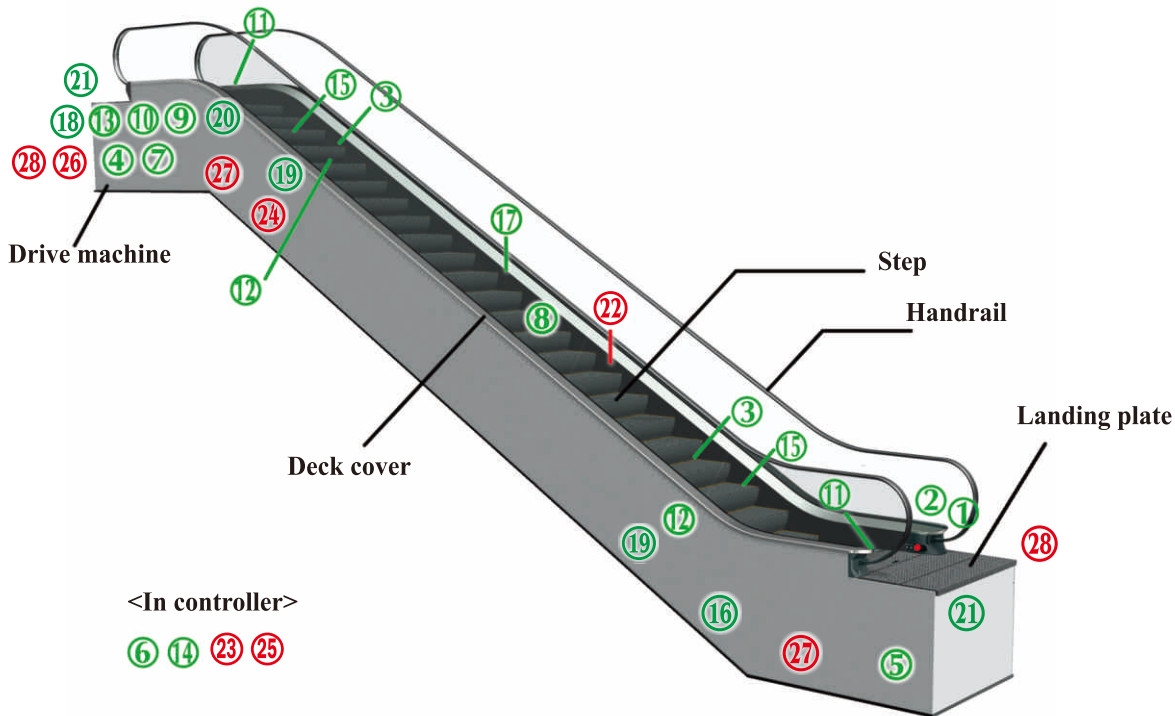

Standard safety devices

1. Handrail safety guard

Stops the escalator when an object is caught in the handrail inlet. See the photo on page 4.

2. Emergency stop button

Stops the escalator when the button is pressed.

3. Skirt guard obstruction safety device

Stops the escalator if a foreign object is caught between the skirt guard and steps.

4. Broken drive-chain safety device

Stops the escalator if the drive-chain is stretched or broken.

5. Broken step chain safety device

Stops the escalator if the step chain is stretched excessively or broken.

6. Electric circuit protection device

Provided with an automatic circuit breaker to protect the escalator circuitry and power supply parts.

7. Brake

Brake is activated to stop the escalator by a spring force action when the power fails or any safety device is activated.

8. Demarcation line

Yellow synthetic resin demarcation lines are provided on the edges of the escalator tread panel in order to prevent passengers from stepping on the edges between adjacent steps and between the step and skirt guard.

(For stainless steel made step)

9. Reversal protection device

Stops the escalator when reverse operation against the preset direction is commanded.

10. Governor

Should the escalator go in overspeed or in a opposite direction against the preset direction, the operation is stopped.

11. Comb safety device

Stops the escalator if a foreign object is trapped between a step and the comb.

12. Step sag safety device

Stops the escalator before the steps enter the comb plate when an abnormal step sag is detected.

13. Auxiliary brake

A mechanically-operated auxiliary brake stops the escalator when the governor is activated. (H>6M)

14. Phase failure (phase-reversal) prevention

The escalator operation is automatically stopped if phase failure or phase-reversal occurs.

15. Step upthrust safety device

Stops the escalator if a foreign object is caught between steps and pushes up the steps.

Optional safety devices

22. Skirt guards panels

The guards are coated with a slippery fluoroplastic to enhance safety.

23. Fire shutter interlocked device

Stops the escalator when the interlocked fire shutter, which is located near the escalator, is activated.

24. Broken handrail safety device

Stops the escalator if either handrail is broken.

25. Tandem operation interlock

Should any one of the escalators in a continuous sequence stop, all the interlocked escalators are stopped.

These escalators are electrically interlocked to run in the same direction.

Handrail safety guard

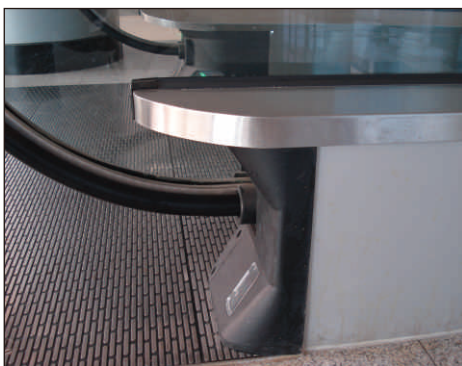

Extended deck cover over the handrail safety guard is designed to prevent accidents at the inlet of handrail.

16. Handrail speed delay sensing device

Stops the escalator if the handrail speed becomes slower than the step speed by more than the preset value.

17. Dress guard

Brushes are provided between the skirt guards and the steps to keep the passengers shoes away from the skirt guard.

18. Brake releasing sensing device

Monitor brake releasing. Escalator can not be started if brake has not released.

19. Step static protective device

Install an anti-static copper brush to prevent static electricity between steps and skirt panels.

20. Handrail static protective device

Install an aluminum roller to prevent static electricity between handrail and guide.

21. Emergency stop button In machine room

Install in the upper and lower machine rooms to stop the escalator

26. Braking distance monitor device

Locked the Escalator if exceeding the maximum permitted stopping distances by more than 20%. (Standard for EN115-1: 2017 code)

27. Step missing device

A missing step shall be detected and the escalator stopped before gap (resulting from the missing step) emerges from the comb. (Standard for EN115-1: 2017 code)

28. Opened floor plate safety device

Stops the Escalator if the floor plate is opened or removed. (Standard for EN115-1: 2017 code)

Note: Necessary safety devices shall be installed according to the applied code.

Dress guard



All Computer Graphics may differ from actual appearance. Specifications and features are subject to change without notice.

Outstanding Features

Standard Specifications

Stylish Newel Design

Innovative design is applied to the newel made of resin, which enhances the individuality. (For S and F type)

⇒ Outstanding appearance

Illuminated Direction Indicator

The illuminated direction indicator installed at the upper and lower newel provides passengers safety with its high level of visibility.

⇒ High level of visibility for safety
⇒ User-friendliness

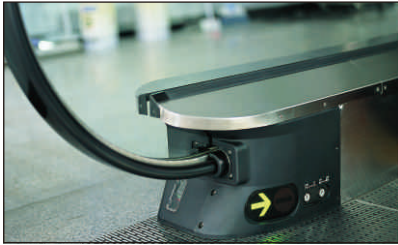

Illuminated Direction Indicator for S and F Type

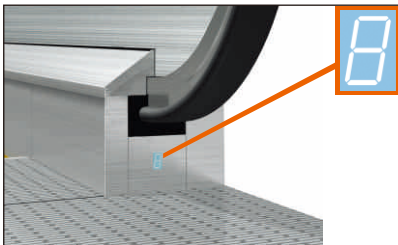

Newel Cover and Fault Display for P Type

Automatic Lubrication System

A central automatic lubrication system lubricates all chains automatically. Galvanized oil collectors come with this system.

⇒ Smooth operation

Rubber Wheel Incorporated in Step Chain

Rubber Wheels integrated with step chain engage with sprocket. (Previously metal step chain engaged with sprocket directly.)

⇒ Superb riding comfort
⇒ Exceptional smoothness & quietness

Stainless Steel Made Step with Demarcation Line

Yellow resin made demarcation lines are provided at the edges of each step for safety.

⇒ User's safety



Demarcation Line

Aluminum Landing Plates

The reverse side of the floor plate can be used during the construction stage to prevent the right face of the plate from any damages by others.

This plate is super-rigid because of its 40mm thickness.

⇒ Longer durability
⇒ Super rigid

Deluxe Balustrade

Durable stainless steel is used for the deck covers

⇒ Longer durability
⇒ Luxurious appearance

Fault Display

It analyzes operational status. When a fault occurs, the cause is displayed on the screen in order to ensure efficient and proper maintenance.

⇒ Efficient & proper maintenance



Fault Display for S and F Type

Color Variety Handrail

Standard Color



HRS-170 Black

Optional Colors



HRN-110 RED



HRN-120 ORANGE



HRN-150 GRAY



HRN-180 BEIGE



HRN-130 BLUE

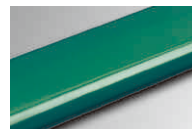

HRN-140 GREEN

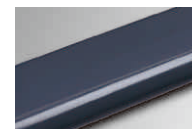

HRN-160 CHARCOAL



HRN-170 Black

The polyurethane handrails hold the advantage of superior resistance to delamination, drive slippage, dust and vandalism. All the handrails are of polyurethane made except that HRS-170 Black is made of synthetic rubber.

Optional Specifications

Painted Demarcation Line

Demarcation lines at the side edges of each step are painted by yellow color for safety.

(For aluminum step only)

⇒ User's safety



Demarcation Lines

Comb Lights

Lights are mounted on the skirt guards at the upper and lower landings, illuminating passenger's steps for easier boarding and exiting.

⇒ User's safety



Comb Lights

Skirt Panel Lights

Accentuates step visibility and the overall line of the escalator to enhance safety.



Skirt Panel Lights (LED Type)

Energy Saving System

Variable frequency operation offers the latest inverter technology, that drastically reduces power consumption. The escalator runs at very low speed under the no load condition and resumes normal operation when approaching passengers are detected by the sensor in the poles located near the landing or the sensor by 3D Type. You can choose either 3D Sensor Type or Pole Type. Slow speed operation prevents passengers from misunderstanding that escalators were out of service. The length of Upper Truss is to be extended by 300mm due to the incorporation of Inverter Unit.

⇒ Less power consumption

⇒ User-friendliness

Demarcation Lights

To help passengers easily identify the boundary line between steps, green fluorescent lights are mounted under the steps. These are located at the upper and lower landings.

⇒ User's safety

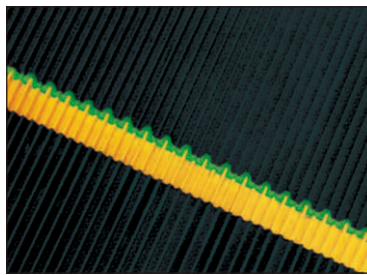

Demarcation Lights

Lights Under Handrail

Illuminates all over the escalator from lights under handrail.

The both fluorescent and LED type are available.



Light Under Handrail

Automatic Start/Stop Operation

The sensors located near the landings detect approaching passengers and automatically start operation. The operation is stopped after all the passengers have exited. You can choose either 3D Sensor Type or Pole Type.

⇒ Less power consumption

⇒ Eco-conscious

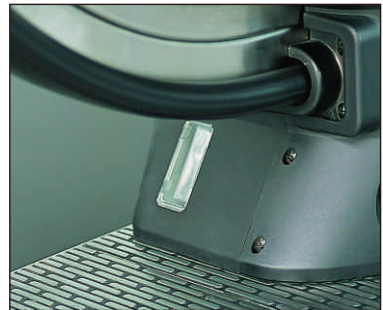

3D Sensor Type for S and F Type

Layout of Escalator Slim & Frame Type for 30-degree (H ≤ 6000)

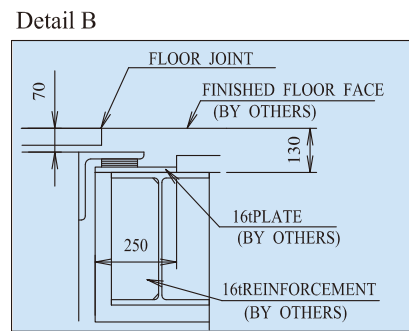
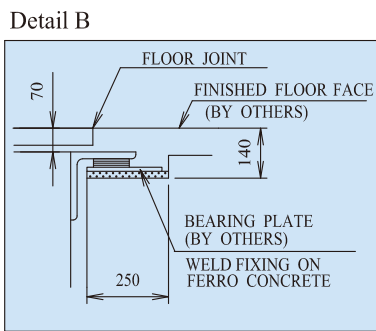
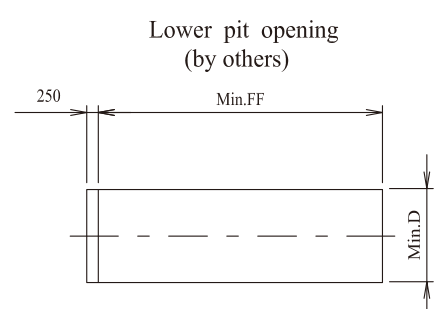
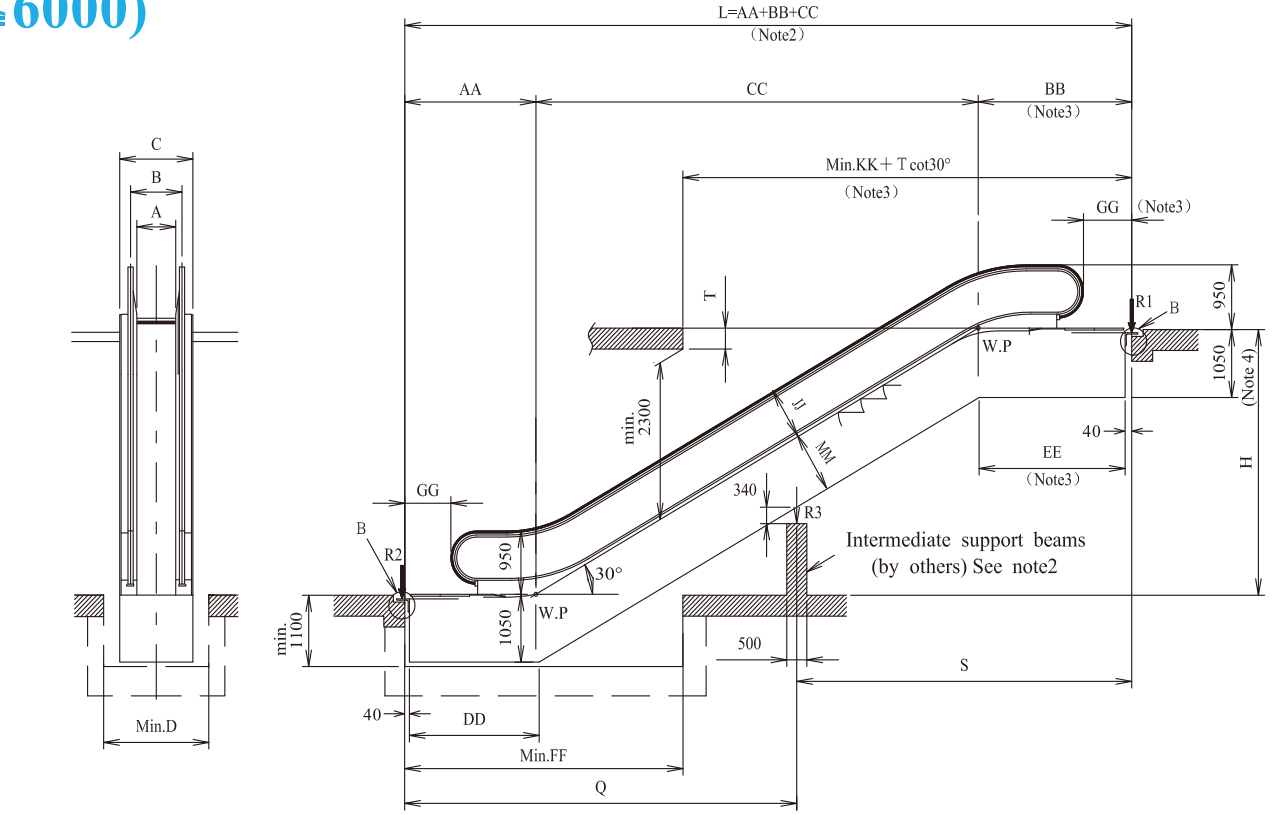

TYPE	AA	BB	CC	DD	EE	FF	GG	JJ	KK	MM	H	Flat steps
S&F	2197	2453	H × 1.732	2168	2402	4250	525	850	6440	915	H ≤ 6000	2

Reactions (KN)

	A	800	1000
A	600	800	1000
B	838	1038	1238
C	1150	1350	1550
D	1250	1450	1650
F	15500	15000	15000

A		R1	R2	R3
600	L ≤ F	$3.66L + 12.09 - 14.97/L$	$3.66L + 2.83 + 14.97/L$	
	L > F	$3.66S + 12.09 - 19.07/S$	$3.66Q + 2.83 - 4.74/Q$	$3.66(S+Q) + 19.70/S + 4.74/Q$
800	L ≤ F	$4.31L + 12.50 - 15.02/L$	$4.31L + 3.19 + 15.02/L$	
	L > F	$4.31S + 12.50 - 20.35/S$	$4.31Q + 3.19 - 5.34/Q$	$4.31(S+Q) + 20.35/S + 5.34/Q$
1000	L ≤ F	$4.97L + 12.92 - 15.09/L$	$4.97L + 3.55 + 15.09/L$	
	L > F	$4.97S + 12.92 - 21.03/S$	$4.97Q + 3.55 - 5.94/Q$	$4.97(S+Q) + 21.03/S + 5.94/Q$

Notes:
 1) The escalator corresponds to European standard EN-115.
 2) If L > F, an intermediate support shall be required.
 3) Add 300mm in case of A=600. Add 300mm in case of A=800 and 1000 with energy saving system. In case of A = 1000 and for indoor use, it is no need.
 4) For outdoor, depth of upper truss is 1100mm, depth of lower pit is 1250mm.

Note: L is in meters.

Layout of Escalator Slim & Frame Type for 30-degree (6000 < H ≤ 9500)

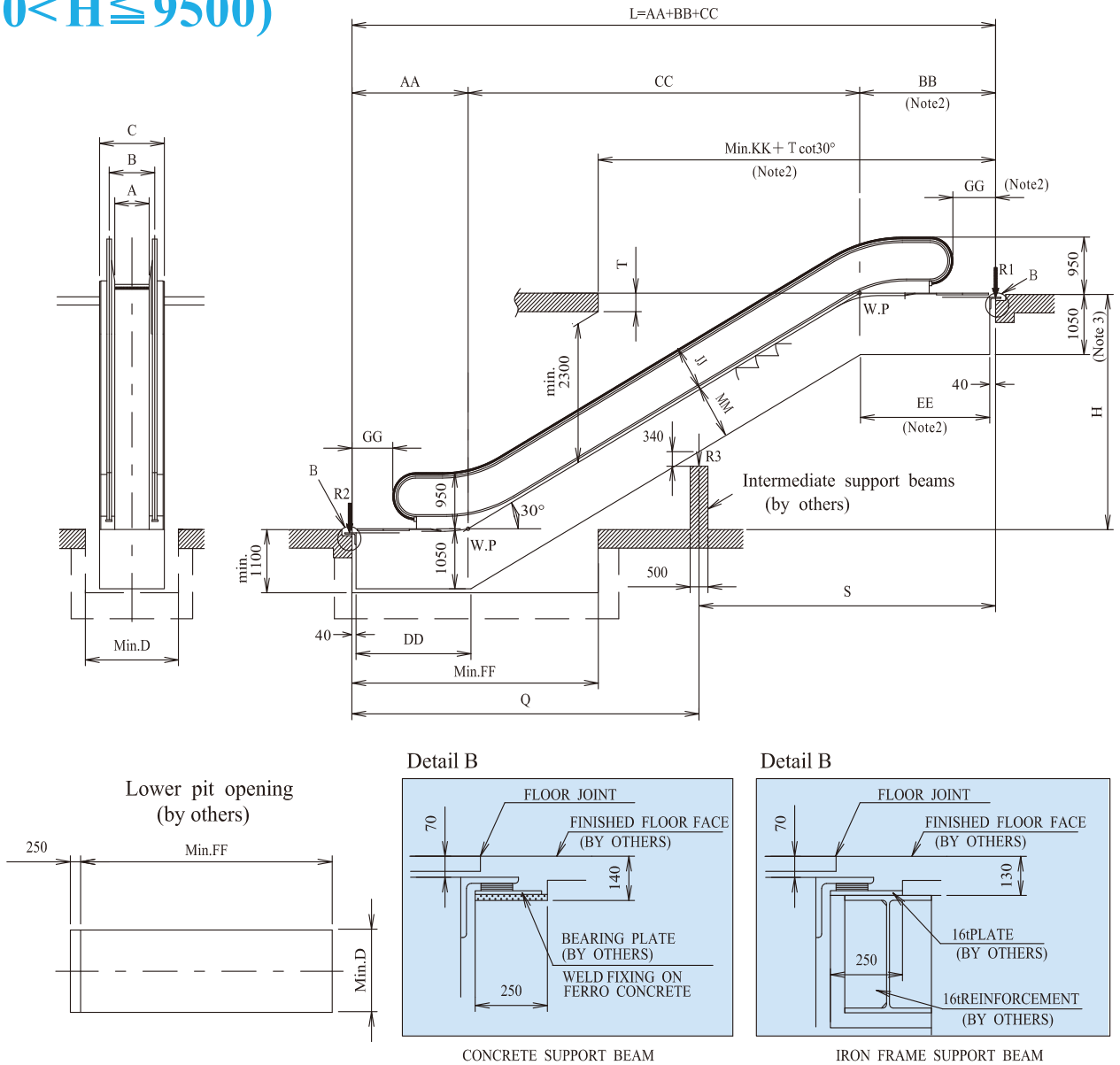

TYPE	AA	BB	CC	DD	EE	FF	GG	JJ	KK	MM	H	Flat steps
S&F	2597	2968	H × 1.723	2568	2917	4650	525	850	6955	915	6000 < H ≤ 9500	3

Reactions (KN)

A	600	800	1000
B	838	1038	1238
C	1150	1350	1550
D	1250	1450	1650

A	R1	R2	R3
600	3.66S+12.09-19.07/S	3.66Q+2.83-4.74/Q	3.66(S+Q)+19.70/S+4.74/Q
800	4.31S+12.50-20.35/S	4.31Q+3.19-5.34/Q	4.31(S+Q)+20.35/S+5.34/Q
1000	4.97S+12.92-21.03/S	4.97Q+3.55-5.94/Q	4.97(S+Q)+21.03/S+5.94/Q

Notes:

- The escalator corresponds to European standard EN-115.
- Add 500mm in case of A=600. Add 300mm in case of A=800 and 1000 with energy saving system. In case of A = 1000 and for indoor use, it is no need.
- For outdoor, depth of upper truss is 1100mm, depth of lower pit is 1250mm.

Note: L is in meters.

Layout of Escalator Slim & Frame Type for 35-degree (H ≤ 6000)

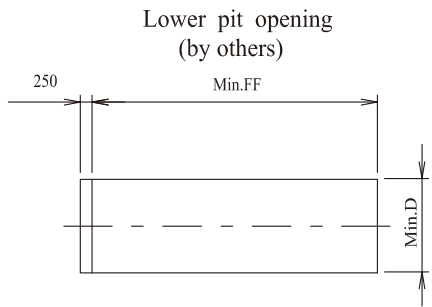
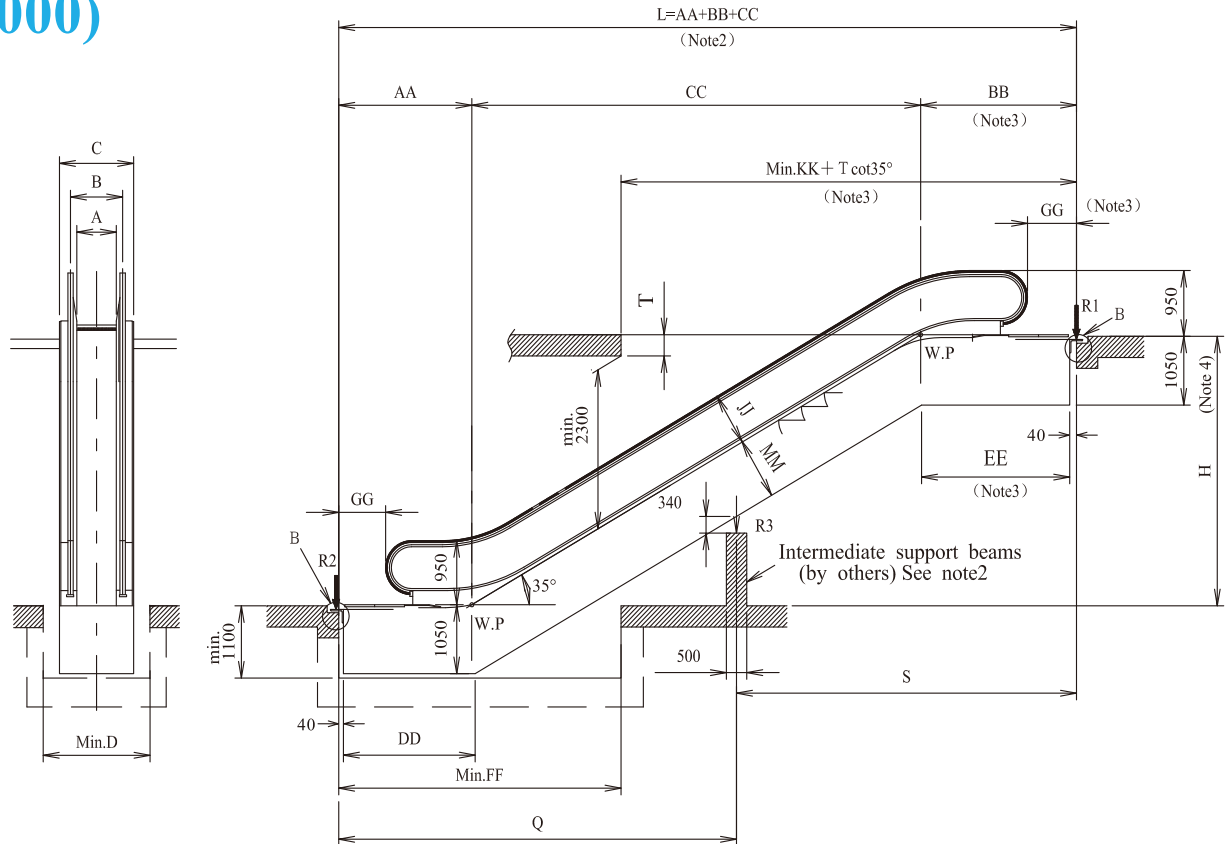

Detail B

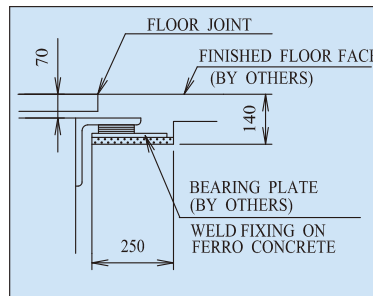

CONCRETE SUPPORT BEAM

Detail B

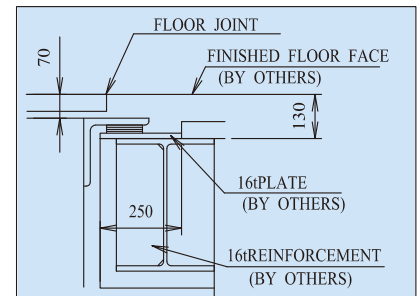

IRON FRAME SUPPORT BEAM

TYPE	AA	BB	CC	DD	EE	FF	GG	JJ	KK	MM	H	Flat steps
S&F	2241	2514	H×1.428	2332	2343	4100	525	830	5800	935	H ≤ 6000	2

Reactions (KN)

A	600	800	1000
B	838	1038	1238
C	1150	1350	1550
D	1250	1450	1650
F	15500	15000	15000

A		R1	R2	R3
600	L ≤ F	3.75L+11.63-15.60/L	3.75L+2.10+15.29/L	
	L > F	3.75S+11.63-18.85/S	3.75Q+2.10-3.56/Q	3.75(S+Q)+18.85/S+3.56/Q
800	L ≤ F	4.40L+12.15-15.51/L	4.40L+2.47+15.51/L	
	L > F	4.40S+12.15-19.70/S	4.40Q+2.47-4.19/Q	4.40(S+Q)+19.70/S+4.19/Q
1000	L ≤ F	5.08L+12.51-15.60/L	5.08L+2.74+15.60/L	
	L > F	5.08S+12.51-20.25/S	5.08Q+2.74-4.65/Q	5.08(S+Q)+20.25/S+4.65/Q

Note: L is in meters.

Notes:

- The escalator corresponds to European standard EN-115.
- If L > F, an intermediate support shall be required.
- Add 500mm in case of A=600.
Add 300mm in case of A=800 and 1000 with energy saving system.
In case of A = 1000 and for indoor use, it is no need.
- For outdoor, depth of upper truss is 1100mm, depth of lower pit is 1250mm.

Layout of Escalator Panel Type for 30-degree (H ≤ 9500)

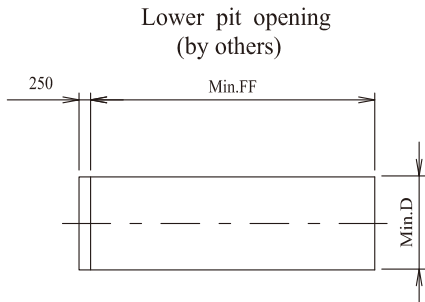
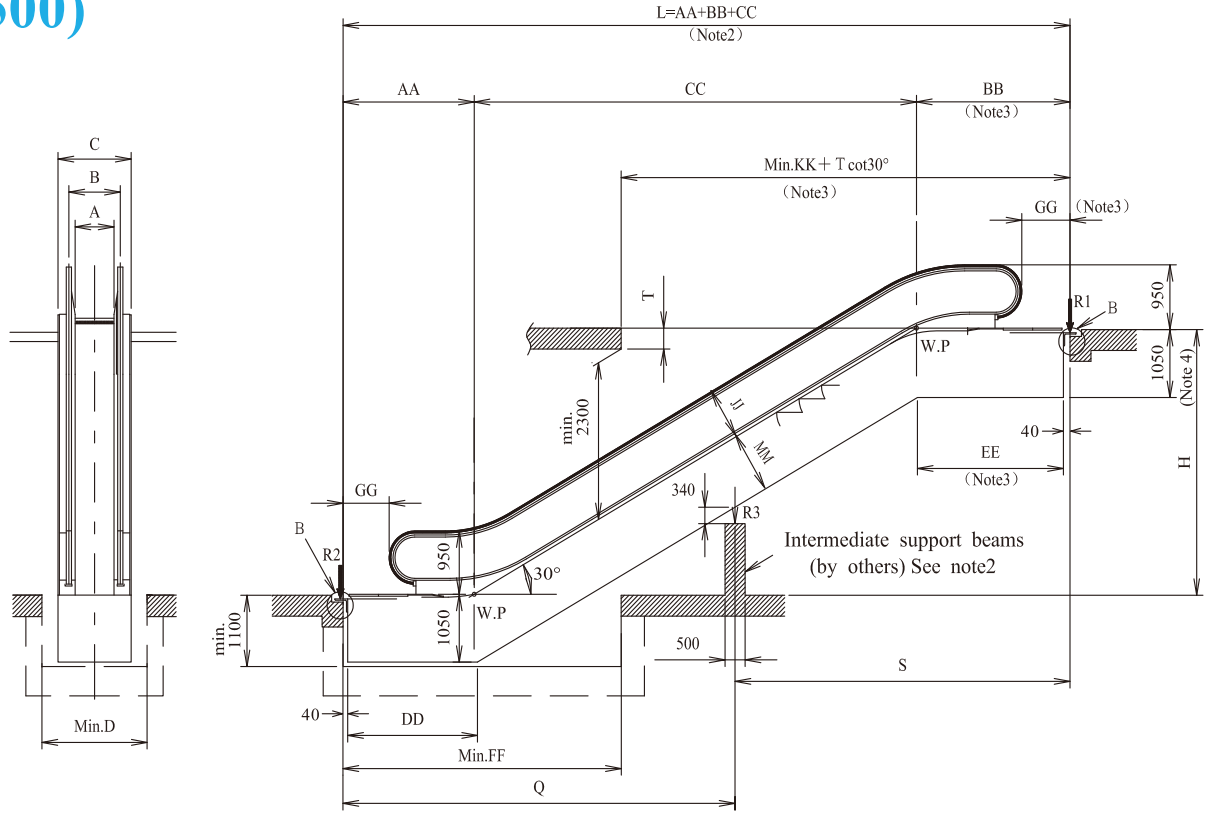

Detail B

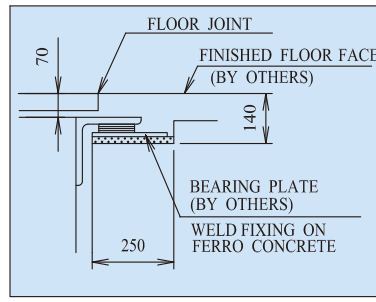

CONCRETE SUPPORT BEAM

Detail B

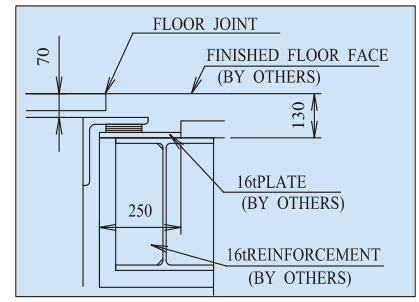

IRON FRAME SUPPORT BEAM

TYPE	AA	BB	CC	DD	EE	FF	GG	JJ	KK	MM	H	Flat steps
P	2197	2568	H×1.732	2168	2517	4250	662	800	6555	915	H ≤ 6000	2
P	2597	2968	H×1.732	2568	2917	4650	662	800	6955	915	H ≤ 9500	3

Reactions (KN)

A	600	800	1000
B	838	1038	1238
C	1150	1350	1550
D	1250	1450	1650
F	15500	15000	15000

A		R1	R2	R3
600	L ≤ F	3.66L+12.09-14.97/L	3.66L+2.83+14.97/L	
	L > F	3.66S+12.09-19.07/S	3.66Q+2.83-4.74/Q	3.66(S+Q)+19.70/S+4.74/Q
800	L ≤ F	4.31L+12.50-15.02/L	4.31L+3.19+15.02/L	
	L > F	4.31S+12.50-20.35/S	4.31Q+3.19-5.34/Q	4.31(S+Q)+20.35/S+5.34/Q
1000	L ≤ F	4.97L+12.92-15.09/L	4.97L+3.55+15.09/L	
	L > F	4.97S+12.92-21.03/S	4.97Q+3.55-5.94/Q	4.97(S+Q)+21.03/S+5.94/Q

Note: L is in meters.

- Notes:
- The escalator corresponds to European standard EN-115.
 - If L > F, an intermediate support shall be required.
 - Add 500mm in case of A=600. Add 300mm in case of A=800 and 1000 with energy saving system. In case of A = 1000 and for indoor use, it is no need.
 - For outdoor, depth of upper truss is 1100mm, depth of lower pit is 1250mm.

Layout of Escalator Panel Type for 35-degree ($H \leq 6000$)

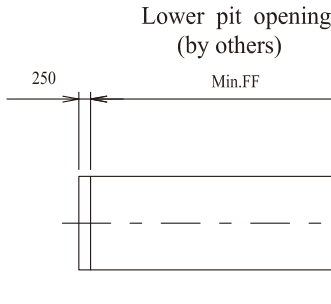
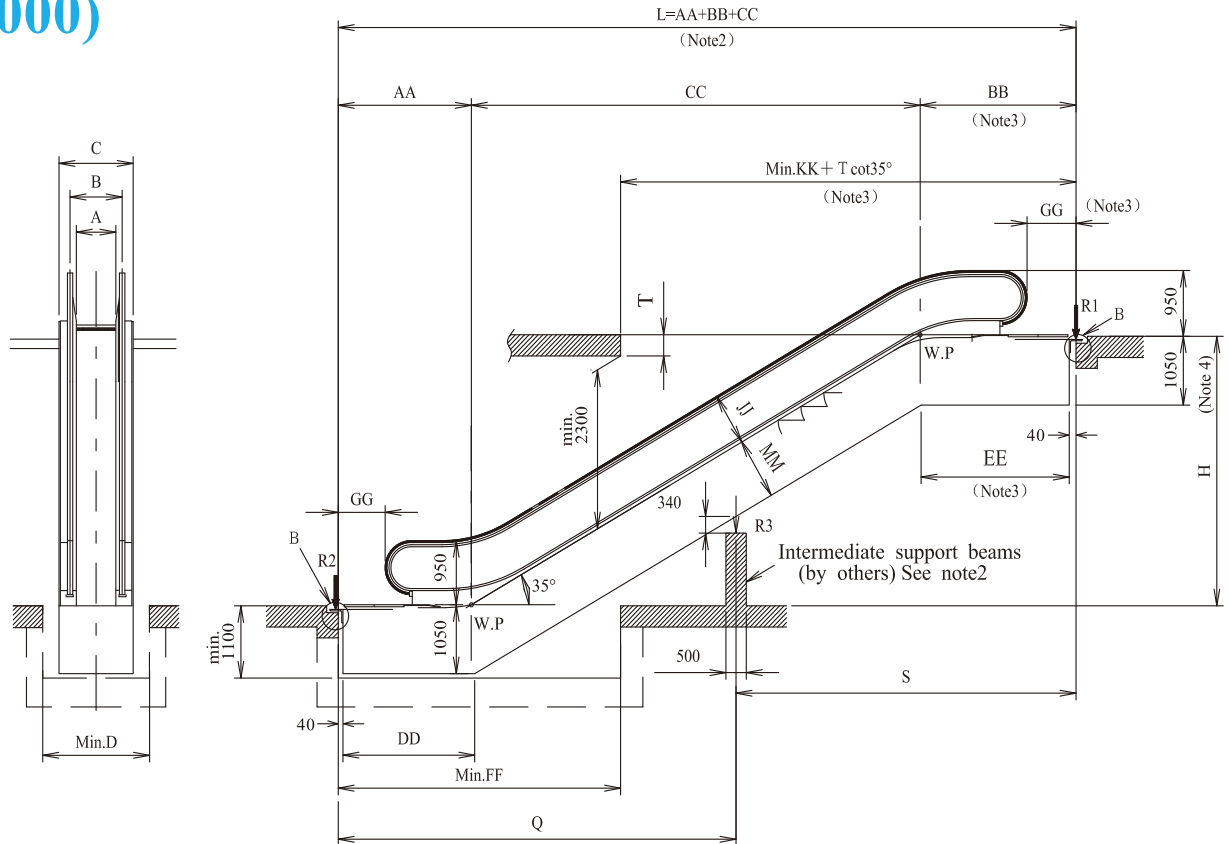

Detail B

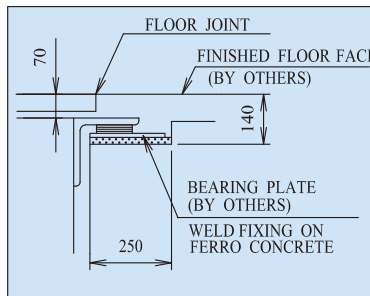

CONCRETE SUPPORT BEAM

Detail B

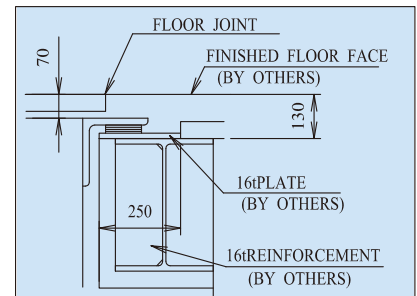

IRON FRAME SUPPORT BEAM

TYPE	AA	BB	CC	DD	EE	FF	GG	JJ	KK	MM	H	Flat steps
P	2241	2664	H × 1.428	2332	2493	4100	662	780	5950	935	H ≤ 6000	2

Reactions (KN)

A	600	800	1000
B	838	1038	1238
C	1150	1350	1550
D	1250	1450	1650
F	15500	15000	15000

A		R1	R2	R3
600	L ≤ F	3.75L+11.63-15.60/L	3.75L+2.10+15.29/L	
	L > F	3.75S+11.63-18.85/S	3.75Q+2.10-3.56/Q	3.75(S+Q)+18.85/S+3.56/Q
800	L ≤ F	4.40L+12.15-15.51/L	4.40L+2.47+15.51/L	
	L > F	4.40S+12.15-19.70/S	4.40Q+2.47-4.19/Q	4.40(S+Q)+19.70/S+4.19/Q
1000	L ≤ F	5.08L+12.51-15.60/L	5.08L+2.74+15.60/L	
	L > F	5.08S+12.51-20.25/S	5.08Q+2.74-4.65/Q	5.08(S+Q)+20.25/S+4.65/Q

Notes:

- The escalator corresponds to European standard EN-115.
- If $L > F$, an intermediate support shall be required.
- Add 500mm in case of $A=600$.
Add 300mm in case of $A=800$ and 1000 with energy saving system.
- In case of $A = 1000$ and for indoor use, it is no need.
- For outdoor, depth of upper truss is 1100mm, depth of lower pit is 1250mm.

Note: L is in meters.

Layout of Escalator Frame & Panel Type for 30-degree (9500 <math>< H \leq 14000</math>)

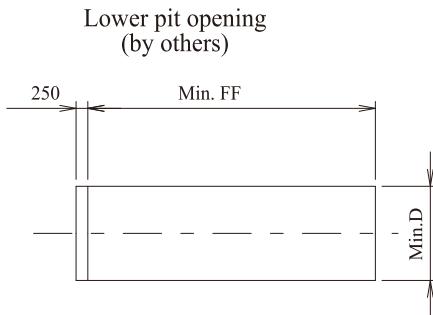
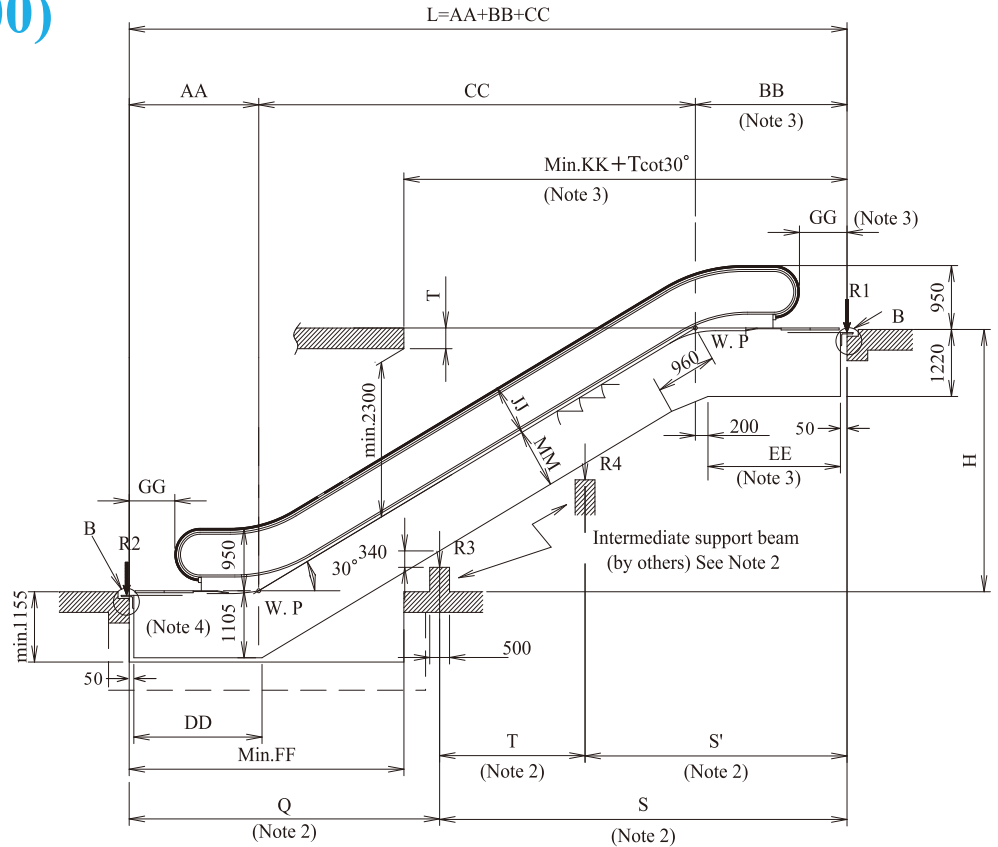
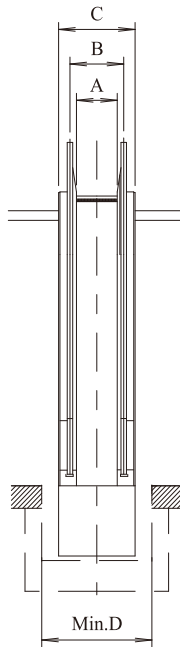

Detail B

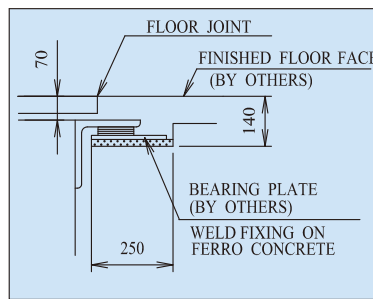

CONCRETE SUPPORT BEAM

Detail B

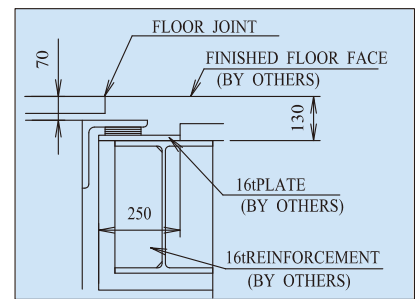

IRON FRAME SUPPORT BEAM

TYPE	AA	BB	CC	DD	EE	FF	GG	JJ	KK	MM	H	Flat steps
F	3015	3435	$H \times 1.732$	2881	3185	5045	780	850	7420	915	$9500 < H \leq 14000$	3
P							847	800				

Reactions (KN)

Model	S600	S800		S1000
A	600	800		1000
		$H \leq 12000$	$H > 12000$	
B	838	1038	1080	1280
C	1150	1350	1410	1610
D	1250	1450	1510	1710

Notes:

- The escalator corresponds to European standard EN-115.
- Q, S, S' and T shall not exceed 11000mm.
- Add 500mm in case of $A=600$.
Add 300mm in case of $A=800$ and 1000 with energy saving system.
In case of $A=1000$ and for indoor use, it is no need.
- For outdoor, Lower pit depth is 1305mm.

Model	A	Intermediate supports	R1	R2	R3	R4
S600	600	1	$4.42S+15.28-27.87/S$	$4.42Q+6.50-12.88/Q$	$4.42(S+Q)+27.87/S+12.88/Q$	
		2	$4.42S'+15.28-27.87/S'$	$4.42Q+6.50-12.88/Q$	$4.42(Q+T)+12.88/Q$	$4.42(S'+T)+27.87/S'$
S800	800	1	$5.11S+15.22-27.11/S$	$5.11Q+6.94-13.76/Q$	$5.11(S+Q)+27.11/S+13.76/Q$	
		2	$5.11S'+15.22-27.11/S'$	$5.11Q+6.94-13.76/Q$	$5.11(Q+T)+13.76/Q$	$5.11(S'+T)+27.11/S'$
S1000	1000	1	$5.81S+20.52-32.69/S$	$5.81Q+7.39-14.63/Q$	$5.81(S+Q)+32.69/S+14.63/Q$	
		2	$5.81S'+20.52-32.69/S'$	$5.81Q+7.39-14.63/Q$	$5.81(Q+T)+14.63/Q$	$5.81(S'+T)+32.69/S'$

Notes:

- Q, S, S' and T are in meters.
- In case that more than two intermediate supports for truss are required, please consult with us.

GS8000 Series Escalators have been operating all over the world

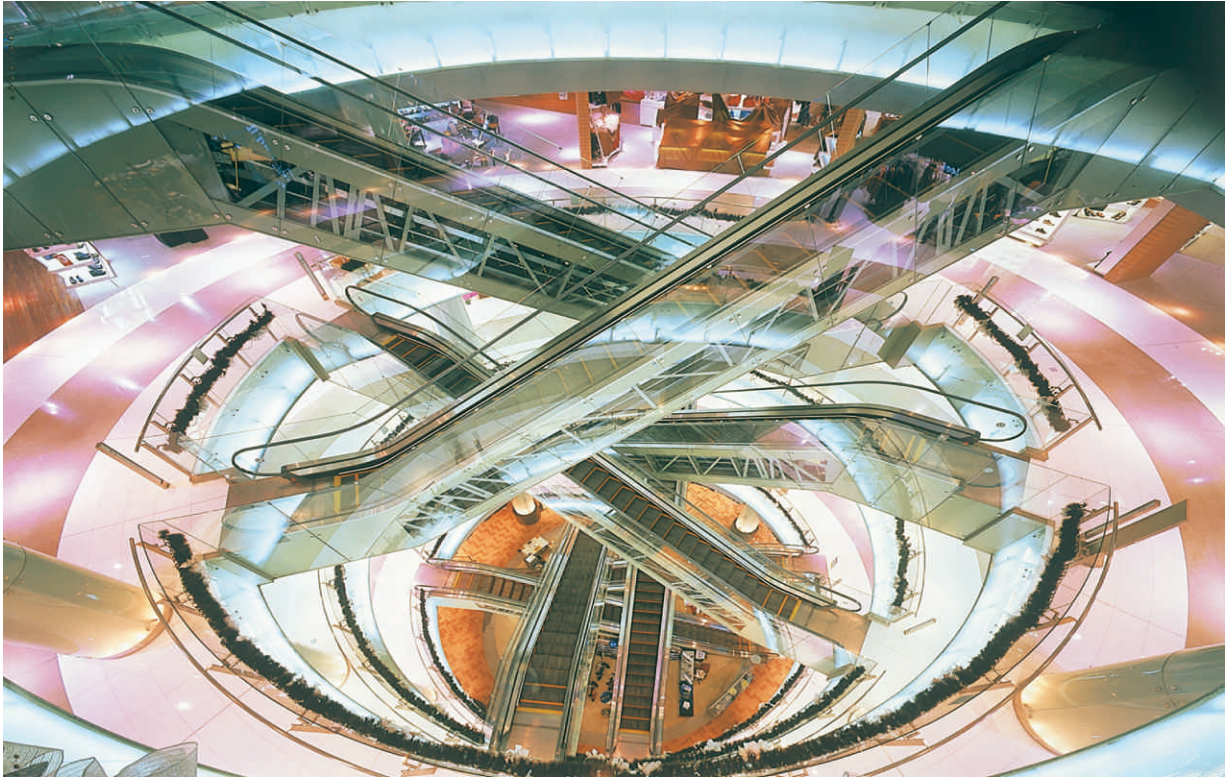

Miramar Entertainment Park
Taipei, Taiwan



Village Caballito
Buenos Aires, Argentina



KLCC
Kuala Lumpur Malaysia



Atlantic Terminal
New York, USA



Chonnam National University Hwasoon Hospital
Chonnam, Korea



Combox
Osaka, Japan

Work by Others

The following work is performed by others.

Construction work

1. Cutouts and holes for installation of escalator.
Installation of support beam.
Installation of hook on ceiling or provision of sleeve hole in ceiling to hoist the deadweight of escalator truss and support beam.
2. Waterproofing work for truss pit.
3. Retouching and finishing work of the areas adjacent to escalator after installation.
4. Installation of parapets around escalator, wedge guards and safety provisions to prevent a fall.
5. Exterior finishing work of the installed escalator.
Installation of lights on exterior cladding.
6. Installation of fireproof shutters and sprinklers.
7. The work to make an entrance and to secure an access path to carry the truss into the building.
Restoration work after installation.
8. Work site area for materials storage.

Electrical work

1. Lead-in work of power supply (main and lighting power supply, ground wires, wiring for supervisory panel, etc.) up to control panel in the machine room.
2. Conduits and wiring from escalator to fire shutter.
3. Provide switch for cladding light.
4. Provide electric power for the installation and adjustment work.
5. Provide emergency light.

Safety precautions to be taken around the escalator

1. Wedge guard shall be provided under the floor ceiling at the point crossing with the escalator (including the soffit panel of the adjacent escalator) to prevent anyone or anything from being caught in the wedges.
2. Provide barrier plate or guard to prevent a fall, if there is an opening between escalator and the building floor.
3. Provide safety net, if there is a clearance of 200mm or over between 2 units of escalator or between an escalator and a floor opening in the building.
4. Provide sign boards, notice boards or public announcement equipment so as to prohibit children from playing on or near the escalator.

Fujitec, Ahead of Its Time

Since its foundation in 1948, Fujitec has always been contributing to modern building transport systems ahead of its time.

We are also one of the most globalized Elevator, Escalator, and Autowalk manufacturers with more than 50 sales or manufacturing locations spreading all over the world.

Fujitec Group Companies Hold ISO 9001 and ISO 14001

The ISO 9000 series is a set of international standards for quality assurance which have been embraced worldwide. Fujitec Japan realized "ISO 9001" certification In March 1993. Following this achievement, Fujitec HongKong, Fujitec Singapore, Fujitec UK, Fujitec Korea, Fujitec Taiwan, Huasheng Fujitec Elevator (China), Fujitec Argentina, and Fujitec Egypt have received ISO9001 certification.

Furthermore, Fujitec Japan, Fujitec Singapore, Fujitec Korea, Huasheng Fujitec Elevator (china) have achieved ISO14001 certification for meeting Environmental Management System Standards.

Fujitec's Global Operation

